



Technical Solution & White Paper

AFDX/ARINC664 End System Testing JS, AIM GmbH 9.7.2012

General

Following Paper outlines the AIM approach for testing AFDX/ARINC664 End Systems against the ARINC664 Specification.

Firstly, an "E/S" is to be understood as outlined in the ARINC664 Specification. (See picture below ARINC664P7 specification page 10).

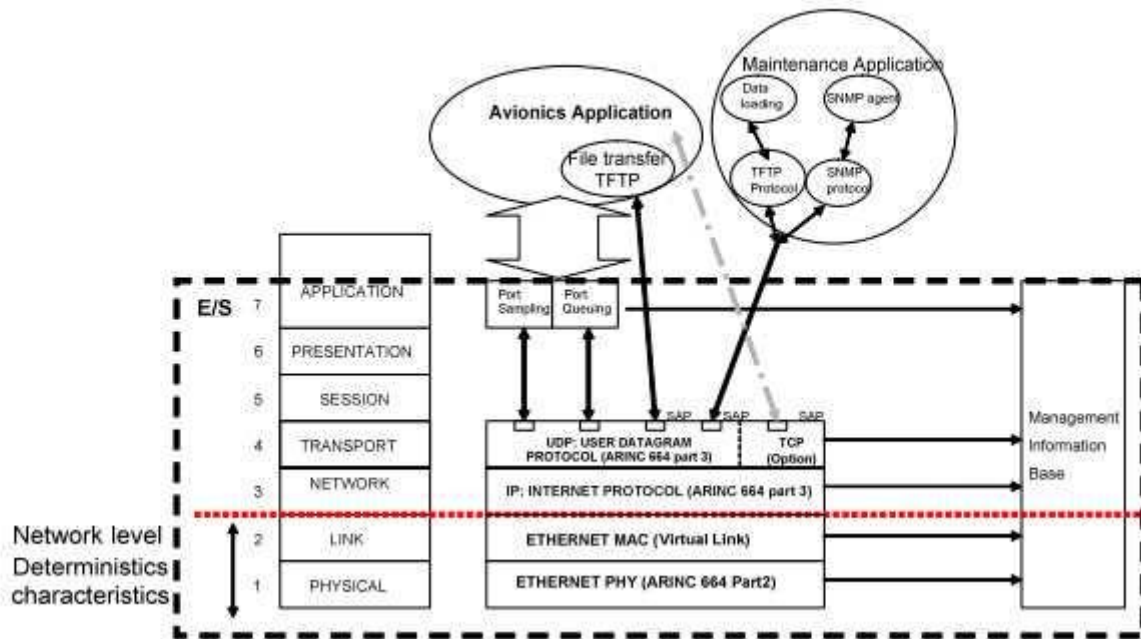

Therefore, an E/S basically offers "only" the Sampling and Queuing Port Services (via AFDX COM and SAP Ports), which are used by an "Avionics Application" (see above) in the final system. For the outlined testing approach below, the "Avionics Application" is replaced by a "Test Application" which replaces the "Avionics Application" to handle all the necessary functionality required by the Test Equipment. The outlined approach is valid for E/S functionality testing (shown above). For this purpose, AIM offers a commercial off the shelf solution comprising the hardware and software and dedicated test scripts.

E/S Testing Approach

The AIM solution for E/S testing is based on using only the AFDX lines for communication with the UUT. No additional interfaces (e.g. serial maintenance or standard Ethernet) are required. For E/S testing a corresponding “Test Application” is required on the UUT for the Test Equipment to verify and command the UUT in order to satisfy the Test Cases.

The “Test Application” has been specified by AIM and is based on standard E/S Services such as AFDX COM and SAP Ports. This specification allows the UUT supplier to implement a Test Application for the UUT and using the available Scripts on the Test Equipment as a semi-off-the-shelf (minor adaptation) solution. Therefore the major effort for any customer is to implement this ‘Test Application’ in accordance with the Test Application specification hosted on their E/S (UUT).

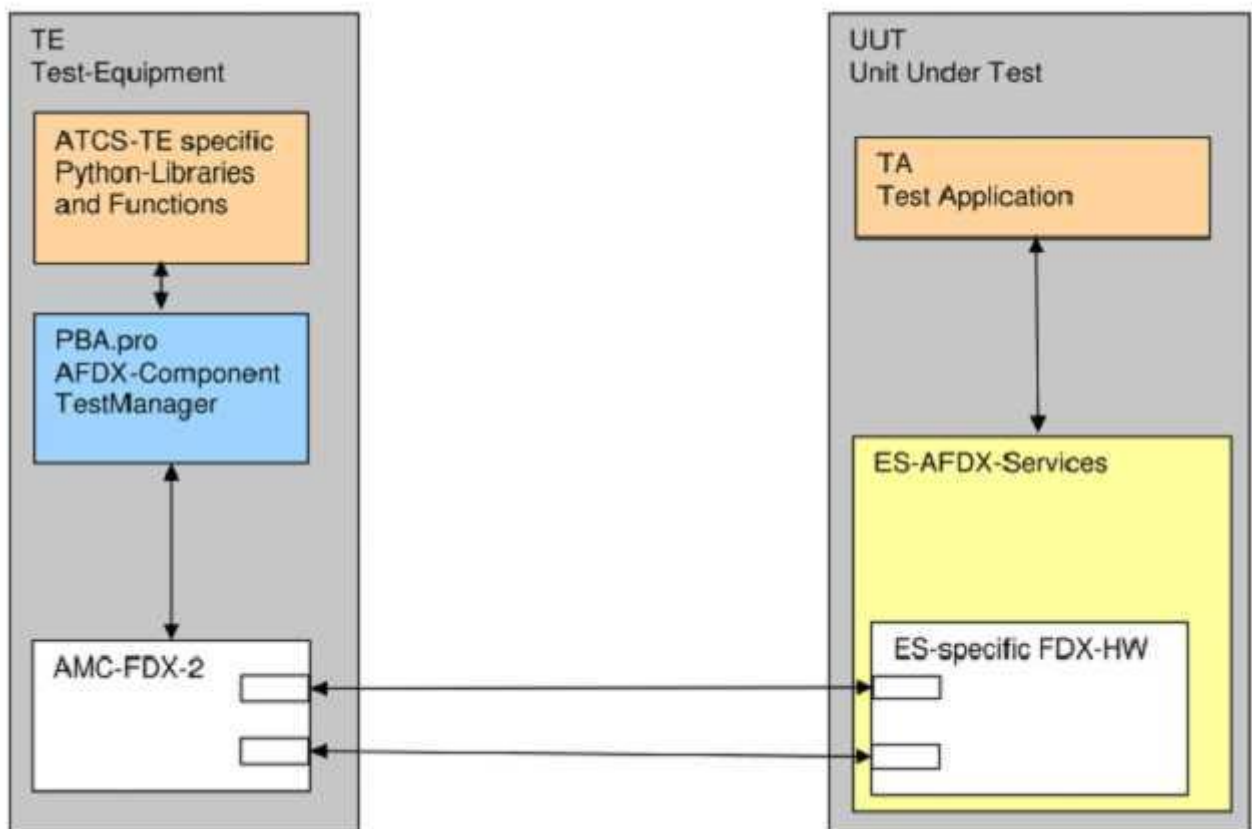

Tests related to 615A Data loading require the use of the AIM EasyLoad615A software.

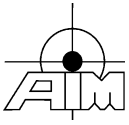

The off-the-shelf test scripts offer tests for checking the compliance of an E/S against the ARINC Specification ARINC664P7, Chapter 3 End System. The functionality and structured is as follows:

E/S System Test Cases Overview

- Basic Communication Tests
- Receive Tests
- Transmit Tests
- Latency Tests
- Performance Tests
- Redundancy Tests
- File Transfer Tests
- Addressing Tests
- Jitter Tests
- MIB Tests
- ICMP Tests

62 Test Cases in total

Following Overview outlines the testing approach and the associated documents relations.

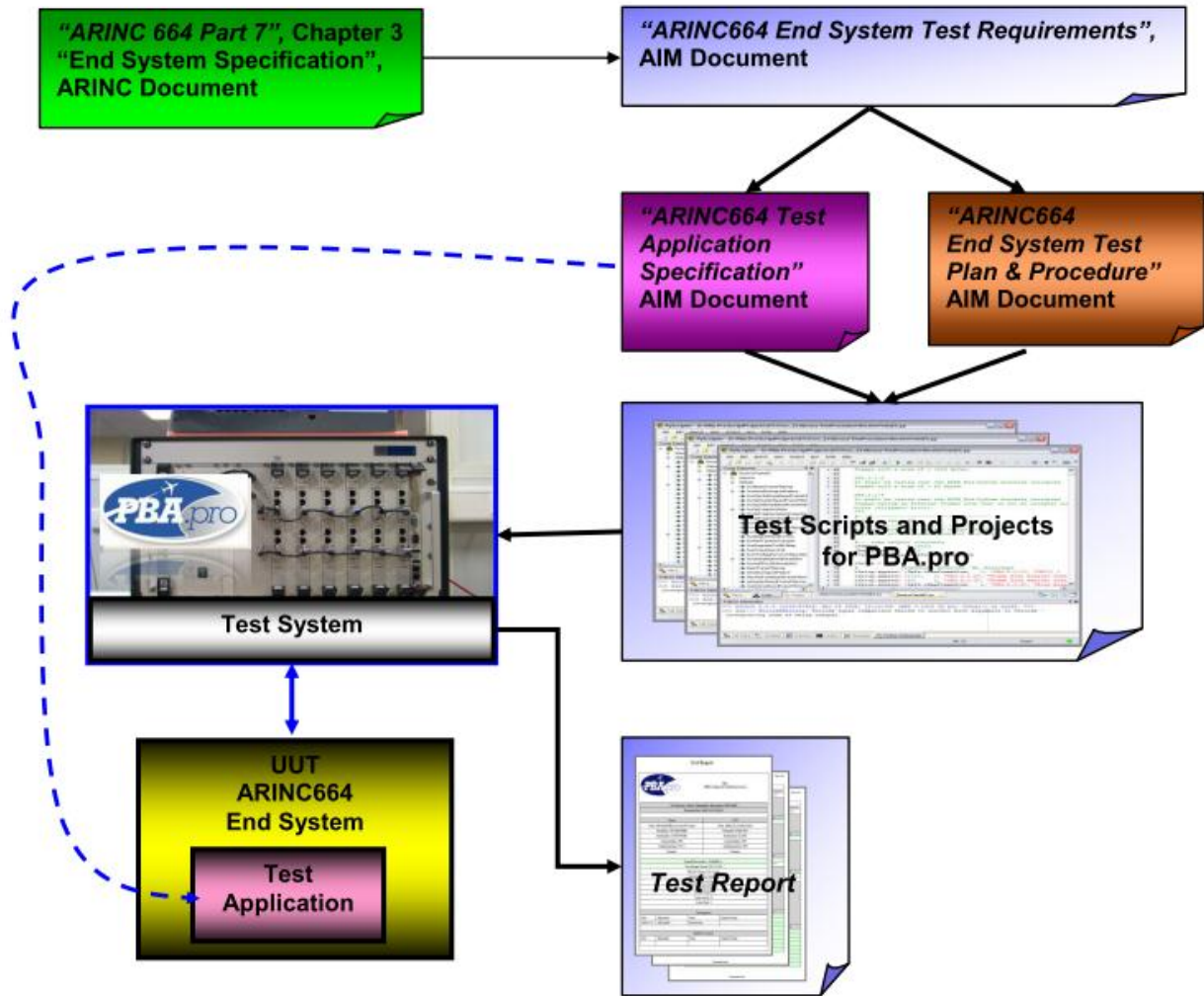

Following picture shows the PBA.pro Test Manager Project, setup with the E/S Testing Project.

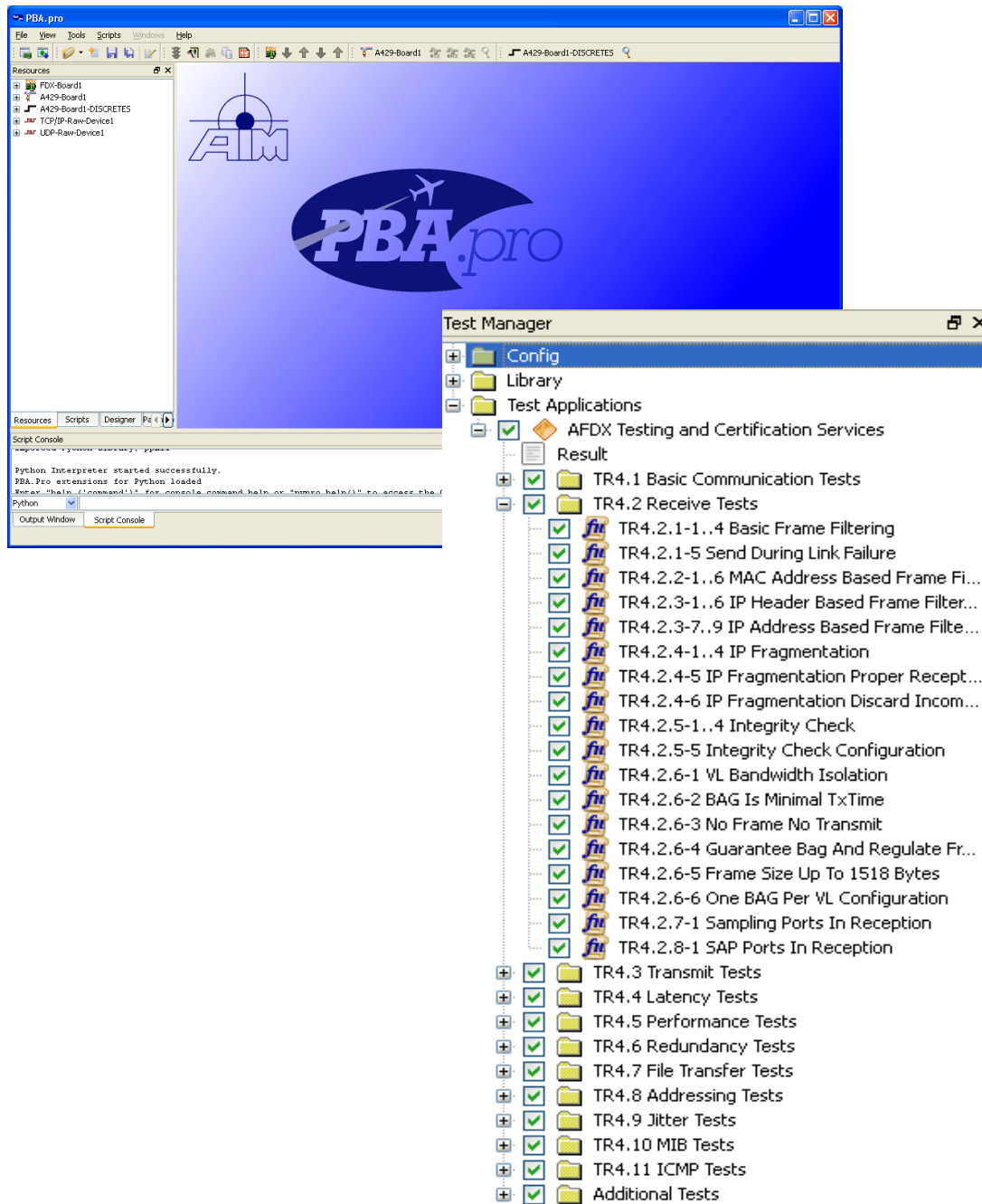

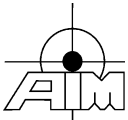

The PBA.pro Test Manager automatically creates a PDF Test Report (customisable) which is shown below (excerpt of a full 14 pages report)

Test Records				
TR	Test	Group Test Result	Performed by	Test-Inspector
	TR4.2.1-5 Send During Link Failure TR4.2.1-5 It shall be tested that the AFDX End-System continues to transmit in case of a physical link failure.			
	Teststeps			Result
	TR4.2.1-5 Send During Link Failure			Passed
	TR4.2.2-1..6 MAC Address Based Frame Filtering It shall be tested that the AFDX End-System: TR4.2.2-1 discards corrupted frames having an error in the MAC destination address constant field (MAC Destination Address error). TR4.2.2-2 discards corrupted frames having an error in the 24 bit MAC source address constant field (MAC Source Address error). TR4.2.2-3 receives all frames having valid value in the 16-bit MAC source address field "User Defined .ID". TR4.2.2-4 receives valid frames having an arbitrary value in the 3-bit MAC source address field "Interface.ID". TR4.2.2-5 discards corrupted frames having an error in the 5-bit MAC source address constant field (MAC Source Address error). TR4.2.2-6 discards corrupted frames having an error in the MAC Protocol Type fields (MAC Type error).			
	Teststeps			Result
	TR4.2.2-1 MAC Destination Address Error on Port 1: all 240 valid messages received as expected.			Passed
	TR4.2.2-2 MAC Source Address 24-bit-const Error on Port 1: all 49 valid messages received as expected.			Passed
	TR4.2.2-3 MAC User Defined ID Error on Port 1: all 21 valid messages received as expected.			Passed
	TR4.2.2-4 MAC Interface ID Error on Port 1: all 8 valid messages received as expected.			Passed
	TR4.2.2-5 MAC Source Address 5-bit-const Error on Port 1: all 10 valid messages received as expected.			Passed
	TR4.2.2-6 MAC Type Error on Port 1: all 49 valid messages received as expected.			Passed
	TR4.2.2-1 MAC Destination Address Error on Port 2: all 240 valid messages received as expected.			Passed
	TR4.2.2-2 MAC Source Address 24-bit-const Error on Port 2: all 49 valid messages received as expected.			Passed
	TR4.2.2-3 MAC User Defined ID Error on Port 2: all 21 valid messages received as expected.			Passed
	TR4.2.2-4 MAC Interface ID Error on Port 2: all 8 valid messages received as expected.			Passed
	TR4.2.2-5 MAC Source Address 5-bit-const Error on Port 2: all 10 valid messages received as expected.			Passed
	TR4.2.2-6 MAC Type Error on Port 2: all 49 valid messages received as expected.			Passed
	TR4.2.2-1..6 MAC Address Based Frame Filtering			Passed

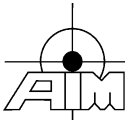

A commercial off the shelf (COTS) solution as described above can be offered from AIM as follows:

- **Test Standard Hardware:** Boards only or the entire System
- **Test Standard Software:** (PBA.pro-FD, PBA.pro-AFDX-2, PBA.pro-TSM, EasyLoad615A)
- **E/S Test Script Package:** PBA.pro-AFDX-ES-TEST (PBA.pro Project and Python Scripts and Libraries) which also includes
 - **End System Test Plan and Procedure:** Text document only
 - **Test Application Specification:** Text document only
 - **Python Test Application Example Template Script:** for execution under PBA.pro with AIM AFDX hardware.